

SLS300F Small Diameter level transmitter

MAIN FEATURES

- Small diameter, capable of inputting 20mm pipes;
- Full welding process, durable and durable;
- Anti interference and anti surge protection;
- Wide measurement range: 0-3m~300mH₂O;
- 316L stainless steel isolation diaphragm, integrated design;



OVERVIEW

SLS300F series input liquid level transmitter is an integrated product based on the principle that the measured liquid static pressure is proportional to the height of the liquid. It uses the Piezoresistive effect of diffused silicon or ceramic sensing elements to convert the static pressure into electrical signals, and then cooperates with special digital circuits to output industrial standard signals through signal amplification, linear compensation, interference resistance, surge protection and other signal processing.

APPLICATION

- Waterworks, chemical plants
- Sewage treatment
- Deep well, dam
- Flood control and irrigation

TYPICAL DIMENSION

MODEL	FEATURE	OUTLINE CONSTRUCTION (Unit:mm)
300F-1	Diameter: 19mm	
300F-2	Diameter: 16mm	
3003-1	Diameter: 22mm	

SPECIFICATION

• Measuring range

Gauge pressure										
H2O	Range	0~1	0~3	0~5	0~10	0~20	0~50	0~100	0~200	0~300
	Over load	3	10	10	25	50	100	200	400	600

Absolute pressure						
H2O	Range	0~20	0~50	0~100	0~200	0~300
	Over load	50	100	200	400	600

• Output signal

Current (2-wire system)	4~20mA
Voltage (3-wire system)	DC 0-10V; DC 0-5V; DC 1-5V; DC ;0.5-4.5V
Proportional voltage (3-wire system)	DC 0.5-4.5V
Digital output	I2C

• Load (Ω)

Current (2-wire system): $\leq (\text{power supply voltage} - 8V)/0.02A$

Voltage (3-wire system): $> \text{Maximum output signal}/1mA$

Proportional voltage (3-wire system): $> 10K$

• Power supply

Signal output	Power supply	
	Default	Optional
4~20mA	DC 8~30V	
0~5V DC		DC 3~5V
1~5V DC		DC 3~5V
0.5~4.5V DC		DC 3~5V
RS485		DC 3~5V
4~20mA+RS485		
4~20mA+Hart	DC 12~30V	
0~10V DC	DC 14~30V	
0.5~4.5V DC(Proportional voltage)	DC 5V±10%	
I2C	DC 3~5V	

• Total current consumption

Current (2-wire system): Signal current, maximum 25mA

Voltage (3-wire system): 2.5mA

Proportional voltage (3-wire system): 2.5mA

RS485: 10uA-10mA

- Accuracy (Room temperature)

Accuracy (Complies with JJG 860 and JJ G882 standards)	Default	Optional
Range \geq 10H2O	0.5%FS	0.25%FS;0.1%FS
Range \geq 3H2O	0.5%FS	0.25%FS
Range \geq 1H2O	1%FS	0.5% FS

- Temperature range

	Range	Default	Optional
Working temperature		-20°C~85°C	-40°C~125°C
Compensation temperature	Range \leq 10H2O	0°C~50°C	
	Range $>$ 10H2O	0°C~70°C	-10°C~80°C
Storage temperature		-40°C~125°C	

- Temperature drift

	Range	Default	Optional
Zero temperature drift	Range $<$ 10H2O	\pm 0.05%FS/°C	\pm 0.02%FS/°C
	Range \geq 10H2O	\pm 0.03%FS/°C	\pm 0.02%FS/°C
Full scale drift	Range $<$ 10H2O	\pm 0.05%FS/°C	\pm 0.02%FS/°C
	Range \geq 10H2O	\pm 0.03%FS/°C	\pm 0.02%FS/°C

- Response time

	Range	Default	Optional
Starting time		100ms	10ms
Response time		10ms	1ms
Stable time	Range \geq 10H2O	15ms	
	Range $<$ 10H2O	1min	

- Long term stability

\leq 0.2% FS/year @ 0.5% FS

- Vibration

10g (IEC 60068-2-6 standard, under resonance conditions)

- Impact resistance

500g (IEC 60068-2-27 standard, mechanical impact)

- Service life

10 million pressure cycles

- Material

	Default	Optional
Diaphragm material	316L	Tantalum; C-276; TC4,5; Al2O3
Shell material	304SS	316L; TC4
Cable material	PUR	PE; PTFE;PVC

WORKING PRINCIPLE

The relationship between liquid pressure and depth:

$$P = P_0 + \rho h$$

Pressure at P-liquid depth h

P_0 -pressure at atmospheric pressure

H-liquid depth

ρ -liquid density

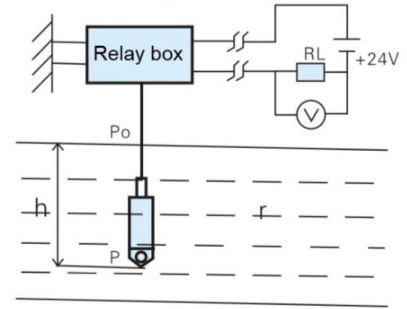

INSTALLATION ATTENTIONS

A. Installation in still water (deep well, pool, liquid tanks)

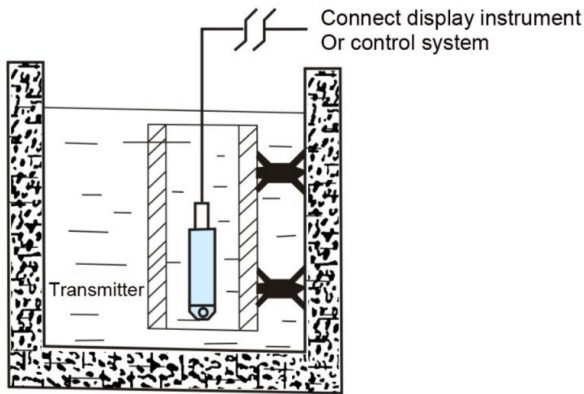

Sewage pond

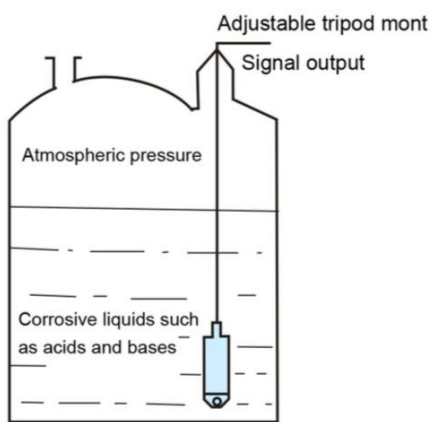
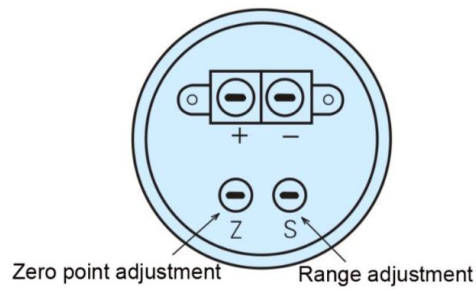

Open tank

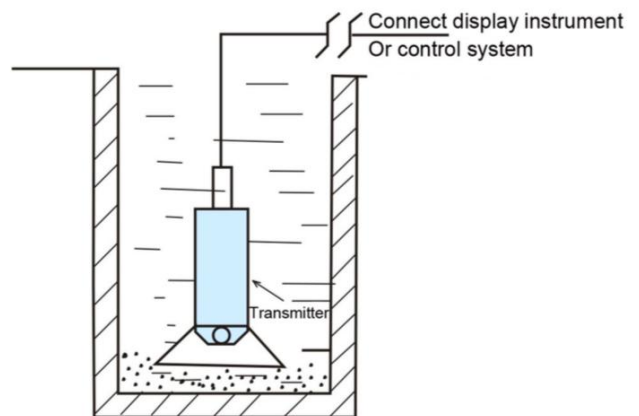

Large installation of sediment

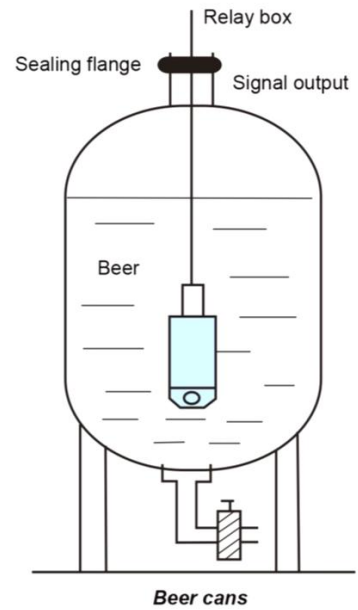
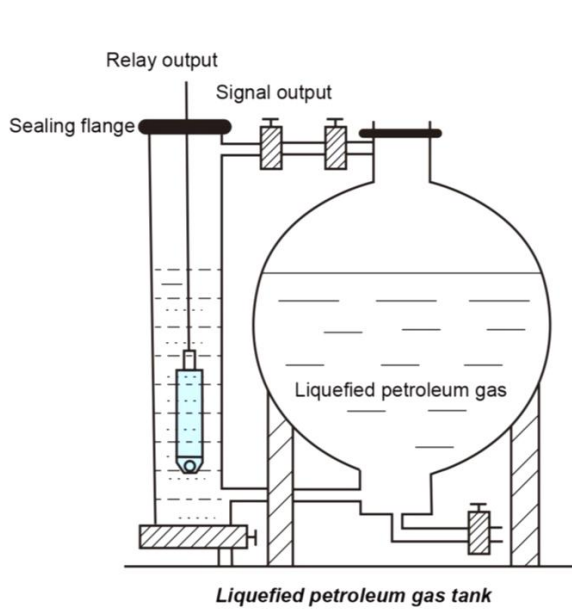

b. installation in moving water

Method 1: When the medium fluctuates greatly, a steel pipe is inserted into the water channel, and the internal strength is about 4.5, and a small number of holes are formed at different heights on the opposite side of the water flow direction, so that the flowing water enters the pipe.

Method 2: When the medium fluctuates greatly, it is also possible to filter the sediment by adding a damping device and eliminate the adverse effects of dynamic pressure and waves to ensure measurement accuracy.

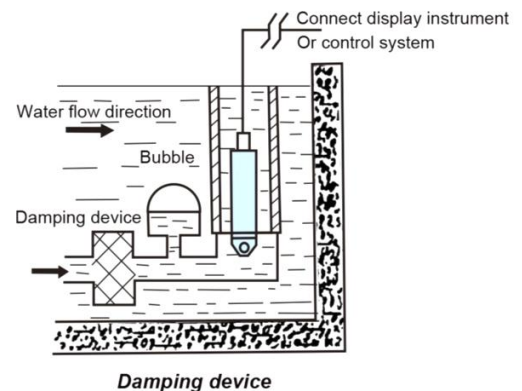
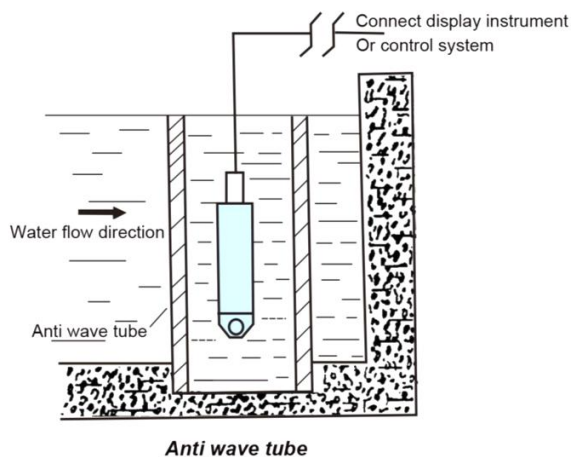

ORDER CODE

Code:	A	-	B	-	C	-	D	-	E	-	F
Model:	SLS300F	-	5m	-	S	-	P1	-	L5	-	MA

Model	Code A
SLS300F-1 Φ19mm	300F-1
SLS300F-2 Φ16mm	300F-2
SLS300F-3 Φ22mm	300F-3
Level Range(X=specific range)	Code B
0m~0.5m...300m	X m
Accuracy	Code C
0.1% (custom)	C
0.25%(typical)	T
0.5%(standard)	S
Cable material	Code D
PVC	P1
Polytetrafluoro(PTEF)	P2
Polyethylene(PE)	P3
PUR	P4
Steel wire	S1
High temperature line	H1
Flame retardant cable	F1
Other customized	C

Cable length	Code E
1m	L1
5m	L5
....	...
200m	L300
Output signal	Code F
4~20mA	MA
0~10V DC	V1
0~5V DC	V5
0.5~4.5V DC	V4.5
I2C	IC
RS485	RS
4~20mA+HART	RS1
4~20mA+RS485	RS2
More output customized	C

Remarks:

1. Please note that the measured medium is compatible with the product part of the contact medium when selecting the type. If you are not sure, please refer to the media compatibility table on the back cover of the instruction manual or consult our company.
2. Please indicate the appropriate measurement range and accuracy requirements when ordering. To ensure product stability and accuracy, it is recommended that the pressure transmitter range be selected based on 120% of the actual measured pressure range. The maximum pressure should be within the measurement range.
3. In order to ensure the reliable operation of outdoor products, users are advised to order transmitters equipped with lightning protection. Ensure that the product and power supply are reliably grounded during installation to reduce the probability of lightning damage to the transmitter.
4. When selecting digital display products, the working temperature range of the transmitter is -30 °C~70 °C.
5. The product is installed vertically on the field pressure interface, and the display level is facing the observer.
6. For medium containing silt sand, the transmitter head needs to take protective measures such as filtering measures to prevent the pressure measuring hole from being clogged or the particles from scratching the diaphragm.
7. When using in hazardous environment such as inflammable and explosive, please install safety barrier according to the regulations. The cable connection should be sealed and reliable. Tighten the junction box cover before powering up to ensure that the transmitter cavity is isolated from the environment. When cleaning, repairing or modifying parameters, the power must be completely removed, the transmitter removed, and moved to a safe environment for processing. On-site live operation is strictly prohibited.